

FELICITA[®]

INCLINE

Operation Manual

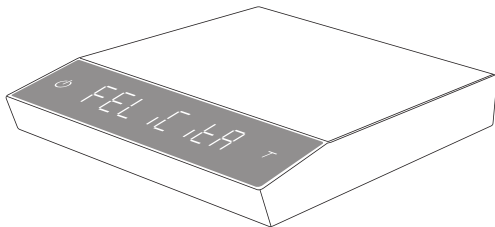

Identification

The instructions in this operation manual apply to the Felicita | Incline. You have purchased a quality precision weighing scale that requires handling with care. Make sure to read through this operation manual prior to using the scale.

CONTENTS

1 Scale at a Glance

- 1 Introduction
- 1 Specifications
- 2 Scale Overview
- 3 Accessories
- 4 Battery Charge

2 Getting Started

- 5 Preparation
- 6 Charging and Setup

3 Quick Start Guide

- 7 Quick Start Guide
- 8 Switch mode
- 9 Timer mode

4 Calibration

- 10 Calibration for felicita Scale
- 11 Simple Calibration Steps

5 1-Year Limited Warranty

- 12 1-Year Limited Warranty

Scale at a Glance

Introduction

1. Thank you for choosing one of our scales. The Felicita | Incline is designed and manufactured to the most rigorous standard to give you the best coffee brewing experience. Start by checking that your Felicita | Incline box contains all the parts listed below:

- | | |
|---|--|
| <ul style="list-style-type: none">• Felicita Incline• Felicita Incline Weight 100g | <ul style="list-style-type: none">• Micro USB cable• Heat Resistant Pad |
|---|--|

2. Next, follow the instructions in the Preparation and Installation sections in the manual to get started.
3. To take an advantage of its many features, carefully read through the operation manual containing step-by-step procedures, examples, and other information.
- 4. Warning: Incorrect handling of this product could possibly result in personal injury or physical damage.**

Specifications

Aprox. weight	288g		
Capacity	2000g / 70.54oz		
Measuring Units	g , oz		
Weighing range	Maximum capacity	2000.0g	70.540oz
	Division	0.1g	0.002 oz
	Reference division	0.01g	0.0005 oz
Indication limit	2060.00g / 72.6600oz		
Unit dimensions	130mm(W) x 160mm(L) x 26mm(H)		
Electrical Requirements	5V/500mA		
Power and Battery	Lithium-ion rechargeable 3.7V 1200mA		
Display	9 digit LED		
Top	Aluminum construction with acrylic window, touch sensitive buttons		
Bottom	Plastic		
Connectivity	Bluetooth 4.0		
Linearity	+/- 0.2g		

Scale Overview

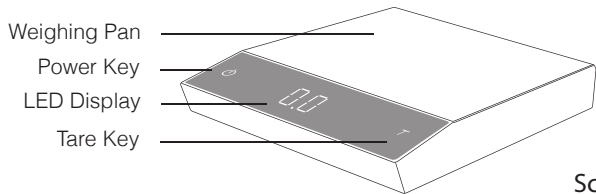

Scale Front

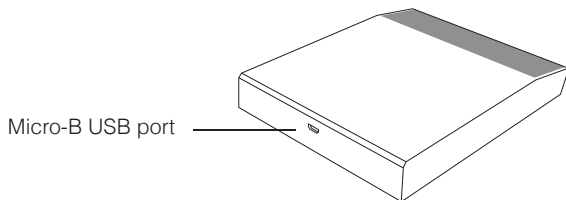

Scale Back

Accessories

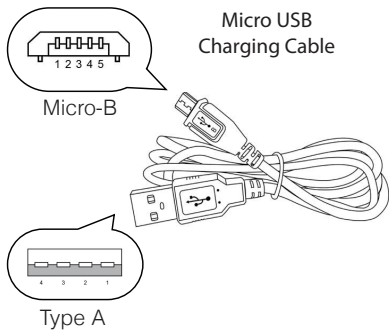

Felicita Scale Weight
100G



Battery Charge

- You can charge the battery by plugging the USB cable to any power supply listed below:
 - A computer USB port
 - A cell phone charger with a micro USB connector
 - An automotive cell phone charger with a USB port or a Micro USB cable
- It takes 1-2 hours to fully charge the battery. You can charge the battery more frequently so that it will never run out of charge.
- Battery percentage can be viewed in Felicita Apps.
- It is not recommended to let the battery run out completely before charge.

Getting Started

Preparation



- This scale is intended for indoor use.

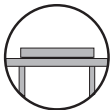

- Select a work place that is stable, vibration-free and, if possible, a horizontal location for the weighing platform.



- Do not locate the scale near any equipment/instrument which contains magnets.

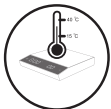

- Avoid places where room temperatures are unstable. Room temperature above 40°C or below 15°C may result in weighing inaccuracy.

Charging and Setup



- To use AC adapter instead of the built-in battery, plug the USB cable into the Micro-B USB port located on the back panel of the scale.



- Press  button for 0.5 seconds to turn on the scale.

Quick Start Guide

1 Turn On

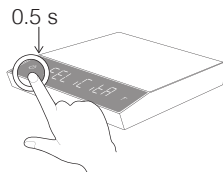

Press "  " to turn on the scale

2 Turn Off

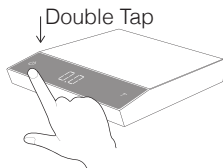

to turn off the scale

3 Tare Weight

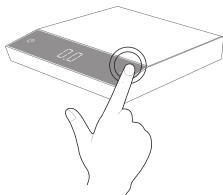

Press " T " to tare zero the weight

4 Switch mode

Press and hold for 2 seconds

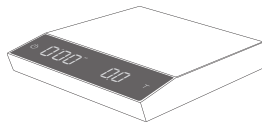
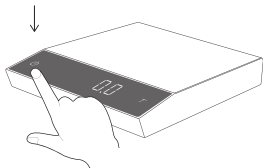

Timer display

Weight display

B



A



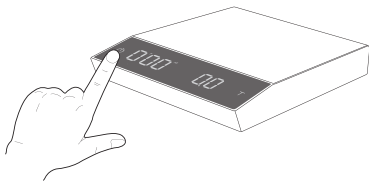

Timer mode

1: Press  button to start the timer

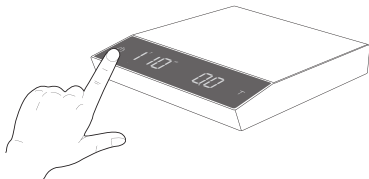

2: Press  again to pause the timer
Press  the third time to recover timing from pausing
The longest time can be timed is 9 min 59s



3: Press and hold  button for 3s
for tare(zero) and reset the timer

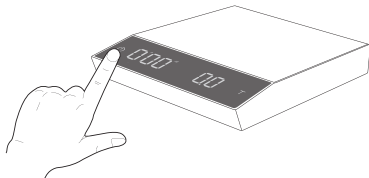

Calibration

Calibration for felicita Scale

1、Purpose

The calibration procedure is designed for users to calibrate the felicita scale periodically in order to maintain the best weighing accuracy.

2、Why Is Calibration Important ?

The weighing sensor dose not only respond to weight, but also temperature effects , surface tilt, gravitational influence, voltage bias,etc. In order to rule out confounding factors and maintain the highest weighing accuracy of the scale, periodic calibration is required.

3、Recommendation

For the felicita scale, it is recommended to calibrate periodically - once per week or every other week. If the felicita scale is moved between two cities, between two environments with different temperatures, or onto a different surface, then the calibration procedure should be performed.

Simple Calibration Steps

- 1 Turn on the felicita scale

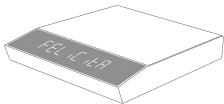

- 2 Make sure the scale is in weighing mode and the unit is set to "gram", then tap the "T" button rapidly and over 6 times

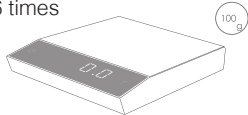

- 3 Keep tapping the "T" button until "[-2E-0]" is shown on the display

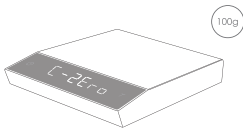

- 4 Place a 100g weight on scale and wait until the display shows "PASS" Calibration is now complete

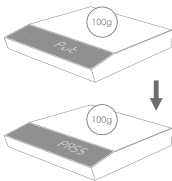

Copyright

The operation manual is protected by copyright. All rights reserved. No part of the operation manual may be reproduced, processed, duplicated or published in any form by photocopying, microfilming, reprinting or any other method, in particular electronic means, without the written agreement of Felicita / Incline.

FELICITA

1-Year Limited Warranty

About warranty issues : Please contact your original place of purchase or your local distributor. Products that are purchased in every country have a one year warranty for parts only. If your product fails within one year date of purchase simply email us at support@felicitacoffee.com. Please have the following information prior to contacting Felicita:

- 1) Proof of date of purchase.
- 2) Model and serial number (located on bottom of the product) Felicita will contact you to determine the problem, and see if it can be fixed quickly and easily.

The customer is responsible for paying the freight charges and any duties for replacement parts that Felicita may send. Customer is also responsible to provide any labor required to repair the product.

The high quality workmanship of Felicita products bearing the Felicita trademark is guaranteed by: **FELICITA CO., LIMITED**



Available on the
App Store



Get it on
Google play

App Free Download

FELICITA[®]
Incline