

the Smart Grinder™ Pro

BCG820 / SCG820



EN QUICK GUIDE

Sage®

CONTENTS

- 2 Sage® Recommend Safety First
- 5 Getting To Know Your New Appliance
- 6 Operating Your New Appliance
- 11 Care, Cleaning & Storage
- 12 Troubleshooting
- 13 Guarantee

SAGE® RECOMMENDS SAFETY FIRST

At Sage® we are very safety conscious. We design and manufacture appliances with your safety foremost in mind. In addition, we ask that you exercise a degree of care when using any electrical appliance and adhere to the following precautions.

IMPORTANT SAFEGUARDS

**READ ALL INSTRUCTIONS
BEFORE USE AND SAVE
FOR FUTURE REFERENCE**

- A downloadable version of this document is also available at sageappliances.com

- Before using the first time ensure your electricity supply is the same as shown on the label on the underside of the appliance.
- Remove and safely discard any packaging materials before first use.
- To eliminate a choking hazard for young children, safely discard the protective cover fitted to the power plug.
- This appliance is for household use only. Do not use the appliance for anything other than its intended use. Do not use in moving vehicles or boats. Do not use outdoors. Misuse may cause injury.
- Fully unwind the power cord before operating.
- Position the appliance on a stable, heat resistant, level, dry surface away from the edge and do not operate on or near a heat source such as a hot plate, oven or gas hob.
- Do not let the power cord hang over the edge of a bench or table, touch hot surfaces or become knotted.
- Do not leave the appliance unattended when in use.
- Always ensure the appliance is turned OFF, unplugged at the power outlet and has been

WE RECOMMEND SAFETY FIRST

- allowed to cool before cleaning, attempting to move or storing.
- Always turn the appliance to the OFF position, switch off at the power outlet and unplug at the power outlet when the appliance is not in use.
 - Do not use the appliance if the power cord, plug, or appliance becomes damaged in any way. If damaged and maintenance other than cleaning is required please contact Sage Customer Service or go to sageappliances.com
 - Any maintenance other than cleaning should be performed by an authorised Sage® service centre.
 - Children should not play with the appliance.
 - Cleaning of the appliance should not be carried out by children unless they are 8 years or older and supervised.
 - The appliance and its cord should be kept out of reach of children aged 8 years and younger.
 - The installation of a residual current safety switch is recommended to provide additional safety when using all electrical appliances. Safety switches with a rated operating current not more than 30mA are recommended. Consult an electrician for professional advice.
 - Do not use attachments other than those provided with the appliances.
 - Do not attempt to operate the appliance by any method other than those described in this booklet.
 - Do not move the appliance whilst in operation.
 - Do not touch hot surfaces. Allow the appliance to cool down before moving or cleaning any parts.
 - This appliance shall not be used by children. Keep the appliance and its cord out of reach of children.
 - This appliance can be used by persons with reduced physical, sensory or mental capabilities or a lack of experience and knowledge, only if they have been given supervision or instruction concerning use of the appliance in a safe way and understand the hazards involved.
 - Do not operate the grinder without the hopper lid in position. Keep fingers, hands, hair, clothing and utensils away from the hopper during operation.

WE RECOMMEND SAFETY FIRST



The symbol shown indicates that this appliance should not be disposed of in normal household waste.

It should be taken to a local authority waste collection centre designated for this purpose or to a dealer providing this service. For more information, please contact your local council office.



To protect against electric shock, do not immerse the power plug, cord or appliance in water or any liquid.

FOR HOUSEHOLD USE ONLY SAVE THESE INSTRUCTIONS

GETTING TO KNOW YOUR NEW APPLIANCE

- A. Bean Hopper Lid
- B. Bean Hopper
- C. Hardened Stainless Steel Conical Burrs
- D. Backlit LCD Screen
- E. GRIND AMOUNT / PROGRAM Dial
- F. SHOTS / CUPS Button
- G. Grind Outlet
- H. Grind Tray
- I. Grind Size Dial
- J. START / PAUSE / CANCEL Button
- K. Portafilter Activation Switch

ACCESSORIES

- L. Portafilter Cradle 50–54mm
- M. Portafilter Cradle 58mm
- N. Conical Burr Cleaning Brush
- O. Grinds Container
 - Oi - Container Cap
 - Oii - Container Lid

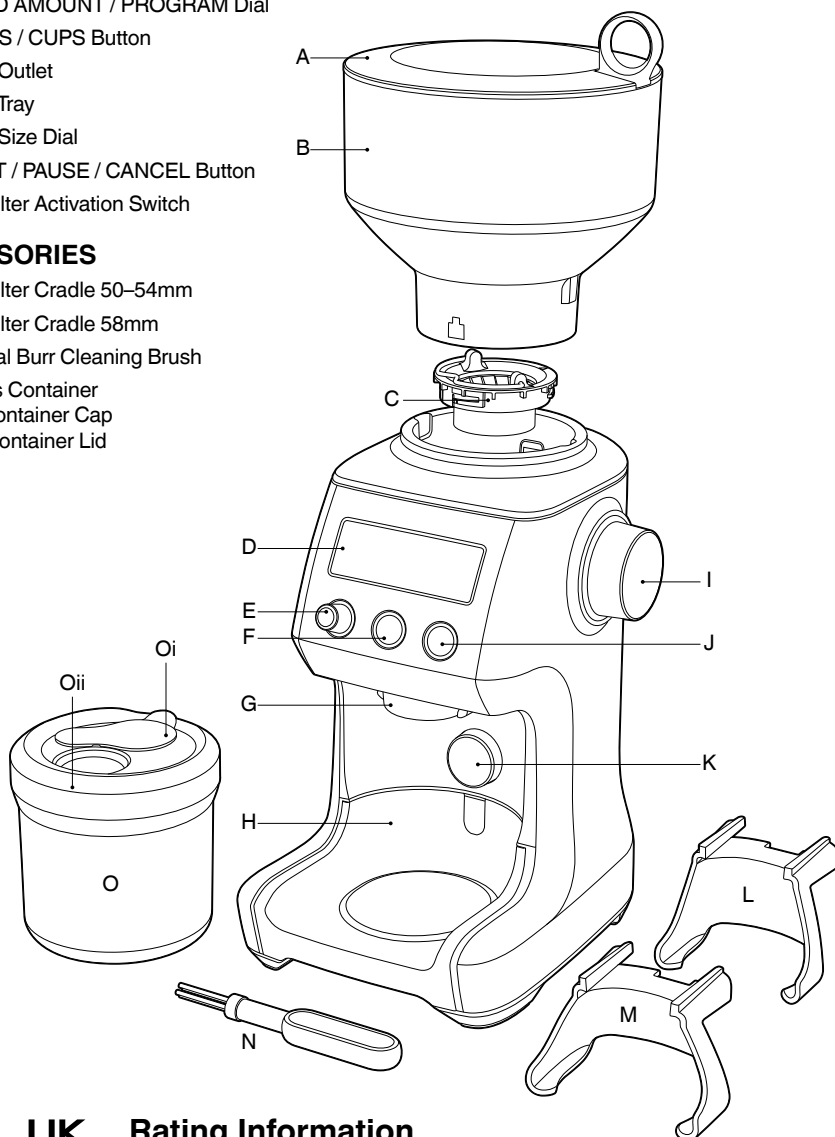

Rating Information
220–240V ~ 50-60Hz 165W

OPERATING YOUR NEW APPLIANCE

BEFORE FIRST USE

Remove and safely discard all promotional labels and packing materials attached to your Sage® product.

Wash hopper, cradles, grind container, container lid and cleaning brush in warm soapy water and dry thoroughly. Wipe exterior of grinder with a soft damp cloth and dry thoroughly. Place grinder on flat level surface and plug power cord into 220–240V outlet and switch Power 'ON'.

ENERGY SAVING FEATURE

The grinder will automatically switch off if not used after 5 minutes.

ASSEMBLING YOUR SAGE SMART GRINDER™ PRO

Bean Hopper

Align tabs on the base of the bean hopper and insert hopper into position. Turn the bean hopper dial 90° to lock into position. Fill with fresh coffee beans and secure lid on top of bean hopper.

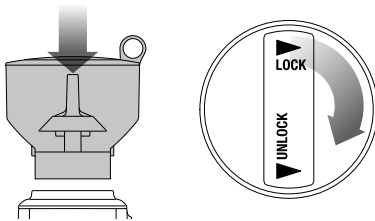

GRINDING FOR ESPRESSO COFFEE

Use single wall filter baskets when grinding fresh coffee beans. Use the finer 1–30 settings in the ESPRESSO range.

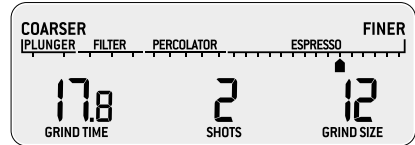

STEP 1:

Insert the appropriate portafilter cradle size. Insert your portafilter into the cradle.

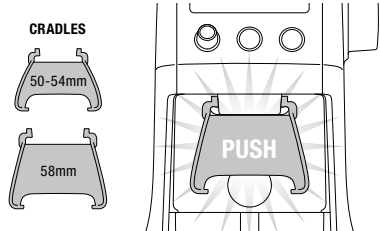

NOTE

Maximum number of shots with the cradle inserted is 2.

COFFEE CHART

BREW METHOD	ESPRESSO	PERCOLATOR	DRIP FILTER	PLUNGER
GRIND SETTING	FINE	MEDIUM	MEDIUM COARSE	COARSE
GRIND SIZE	1-30	31-45	46-54	55-60
AMOUNT	1 UP TO 8 SHOTS	1 UP TO 12 CUPS	1 UP TO 12 CUPS	1 UP TO 12 CUPS

OPERATING YOUR NEW APPLIANCE

STEP 2:

Selecting your SHOTS / CUPS

Select the desired amount of ground coffee required by pressing the SHOTS / CUPS button.

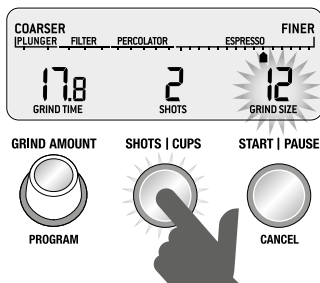

Rotate the Grind Amount Dial to adjust the grinding time to achieve the correct amount of coffee.

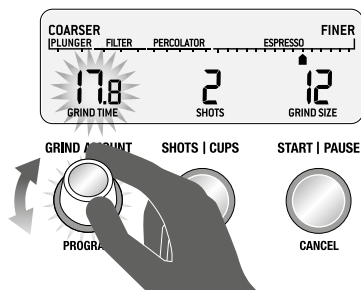

STEP 3:

Select your grind size

For espresso, we recommend selecting Grind Size setting 12 as a starting point and moving the Grind Size dial Coarser or Finer to adjust the flow of espresso as required.

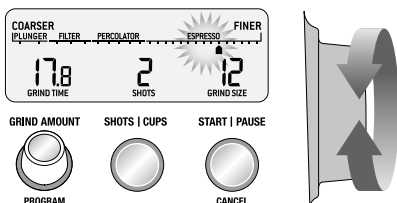

NOTE

If the Grind Size Dial is tight, run the grinder by pressing the START / PAUSE / CANCEL button while turning the Grind Size Dial. This will release coffee grounds caught between the burrs.

GRINDING INTO GRINDS CONTAINER OR COFFEE FILTER

STEP 1:

Remove cradle by sliding out from under the grind outlet.

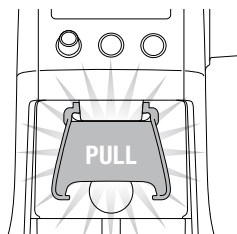

Slide in grinds container with cap open or coffee filter directly under grind outlet.

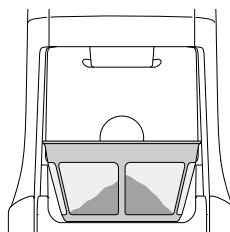
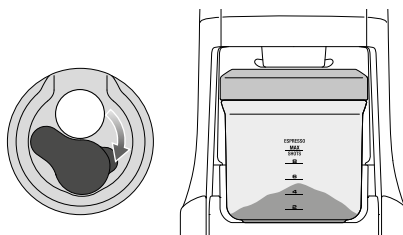

OPERATING YOUR NEW APPLIANCE

- Select the required amount of ground coffee by pressing the SHOTS / CUPS button.
- Press the START / PAUSE / CANCEL button to start grinding operation.

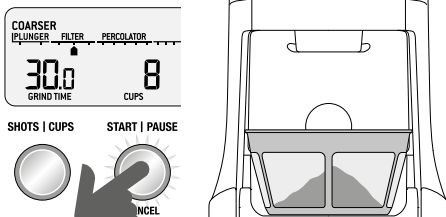
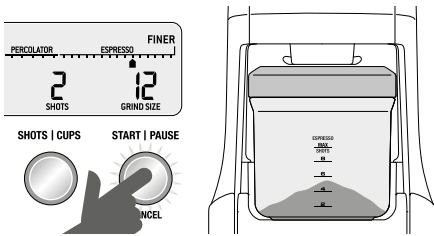

FEATURES OF YOUR SAGE SMART GRINDER™ PRO

Automatic Grinding

Grinding automatically allows you to grind hands-free.

- Press and release either the START / PAUSE / CANCEL button or push the handle of your portafilter once. This will activate the PORTAFILTER SWITCH.
- Grinding will automatically stop when the preset amount is dispensed.

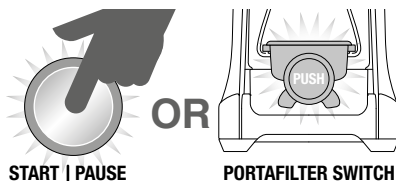

PRESS & RELEASE

NOTE

Programming a custom grind amount/time only sets it for that particular brew method. This will not change the other Shots or Cups settings.

Pause Function

You can pause the grinder during operation allowing you to collapse or settle the coffee in the portafilter.

- Press and release the START / PAUSE / CANCEL button to start the grinding operation.
- During grinding, press the START / PAUSE / CANCEL button again to pause the operation for 10 seconds.
- Press again within this time to resume grinding the remaining dose.

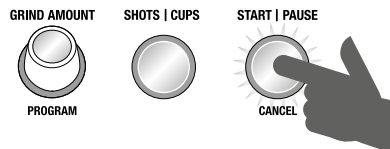
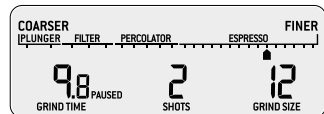

OPERATING YOUR NEW APPLIANCE

Program Function

Once you have set your required dose, you can program this time into the number of shot(s) currently displayed on the LCD. Press and hold the PROGRAM button, grinder will beep twice to confirm. Only the shot displayed will be programmed, all other shots will remain unchanged.

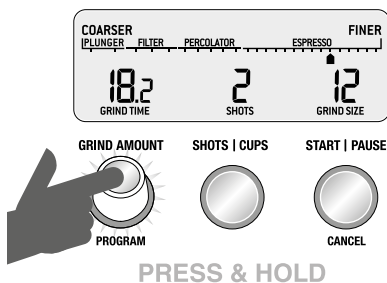

Manual Grinding

Grinding manually allows you to have complete control over how much coffee is dispensed.

- Press and hold either the START / PAUSE / CANCEL button or push the handle of your portafilter to activate the PORTAFILTER SWITCH for as long as you require.
- Release START / PAUSE / CANCEL button or PORTAFILTER SWITCH and grinding will stop.

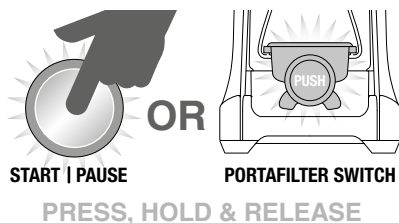

ADJUSTING YOUR GRIND AMOUNT

Increasing the Grind Amount

To increase the grind amount selected, turn the GRIND AMOUNT dial to the right.

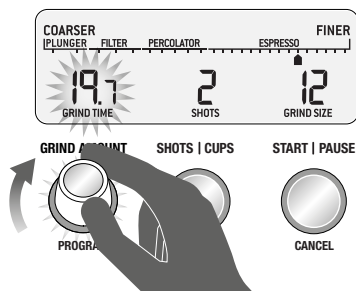

Decreasing the Grind Amount

To decrease grind amount selected, turn the Grind Amount Dial to the left.

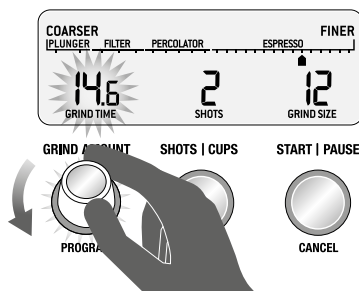

NOTE

To RESET the grind amount/time to the default settings, press and hold the SHOTS / CUPS button until a long beep sounds.

OPERATING YOUR NEW APPLIANCE

ADJUSTING CONICAL BURRS

Some types of coffee may require a wider grind range to achieve an ideal extraction or brew. A feature of your Smart Grinder™ Pro is the ability to extend this range with an adjustable upper burr. We recommend making only one adjustment at a time.

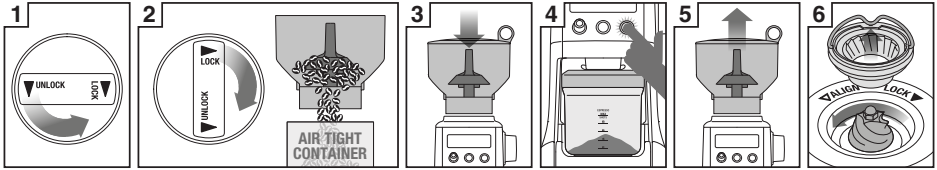

1 Unlock hopper

2 Hold hopper over container & turn dial to release beans into container

3 Align hopper into position

4 Run grinder until empty

5 Remove hopper

6 Remove upper burr

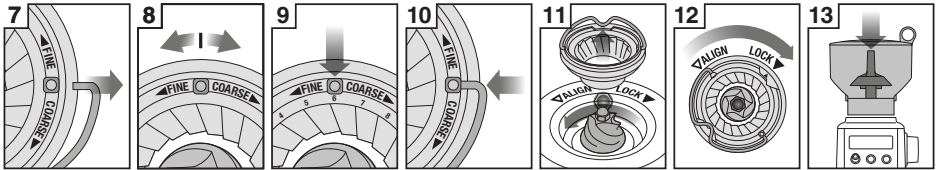

7 Remove wire handle from both sides of the burr

8 Move adjustable top burr, 1 number coarser or finer

9 Align the number with the handle opening

10 Insert wire handle from both sides of the burr

11 Push upper burr firmly into position

12 Lock upper burr

13 Align hopper into position

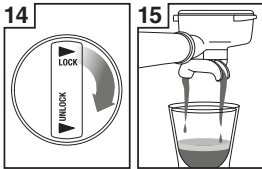

14 Lock hopper

15 Check your extraction

CARE, CLEANING & STORAGE

CARE, CLEANING & STORAGE

1. Empty beans from the hopper and grind out any excess beans (see below).
2. Unplug power cord from power outlet before cleaning.
3. Wash the grind container and lid, bean hopper and lid in warm soapy water, rinse and dry thoroughly.
4. Wipe and polish exterior of appliance with a soft damp cloth.

NOTE

Do not use alkaline or abrasive cleaning agents, steel wool or scouring pads, as these can damage the surface.

NOTE

Please do not clean any grinder parts or accessories in the dishwasher.

CLEANING CONICAL BURRS

Regular cleaning helps the burrs achieve consistent grinding results which is especially important when grinding for espresso coffee.

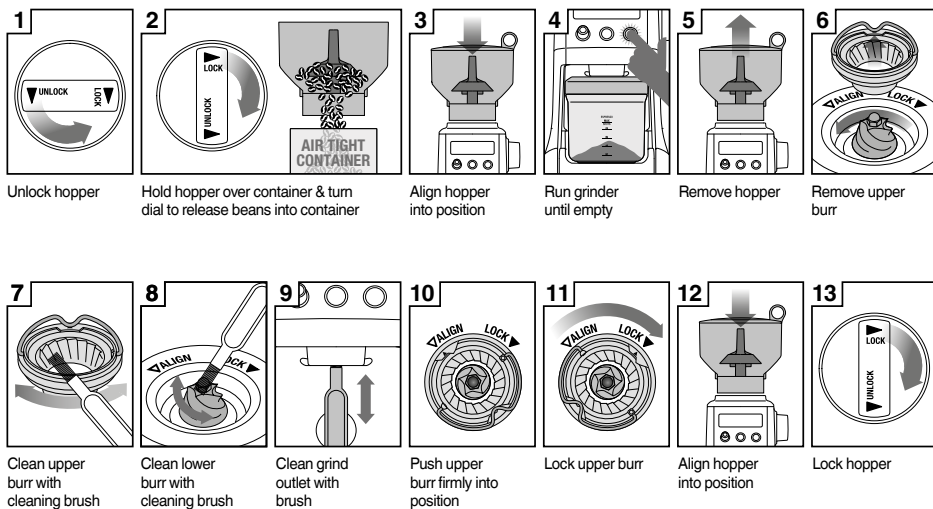

TROUBLESHOOTING

PROBLEM	POSSIBLE CAUSE	WHAT TO DO
Grinder does not start after pressing START / PAUSE / CANCEL button	<ul style="list-style-type: none"> • Grinder not plugged in. • Grinder has overheated. • Bean hopper not attached correctly. 'PLEASE LOCK HOPPER' will be displayed on LCD screen. 	<ul style="list-style-type: none"> • Plug power cord into power outlet. • Remove power plug from power outlet. Leave for 20 minutes to cool down before using again. • Lock bean hopper into position.
Motor starts but no ground coffee coming from grind outlet	<ul style="list-style-type: none"> • Incorrect button pressed. • No coffee beans in bean hopper. • Grinder/bean hopper is blocked. 	<ul style="list-style-type: none"> • Press START / PAUSE / CANCEL or PORTAFILTER SWITCH to activate. • Fill bean hopper with fresh coffee beans. • Remove bean hopper. Inspect bean hopper and burrs for blockage. Replace parts and try again.
Motor starts but operates with a loud 'racket' noise	<ul style="list-style-type: none"> • Grinder is blocked with foreign item or chute is blocked. • Moisture clogging grinder. 	<ul style="list-style-type: none"> • Remove bean hopper, inspect burrs and remove any foreign body. • Clean burrs and chute (refer to Care & Cleaning on page page 11). • Leave burrs to dry thoroughly before re-assembling. You can use a hair dryer to blow air into grinder inlet (lower burr) to dry.
Unable to lock bean hopper into position	<ul style="list-style-type: none"> • Coffee beans obstructing bean hopper locking device. 	<ul style="list-style-type: none"> • Remove bean hopper. Clear coffee beans from top of burrs. Re-lock hopper into position & try again.
Not enough/ too much coffee grind	<ul style="list-style-type: none"> • Grind amount requires adjustment. 	<ul style="list-style-type: none"> • Press SHOTS / CUPS button to change grind amount. • Use Grind Amount Dial to fine tune the amount 'more' or 'less'.
Portafilter overfills		<ul style="list-style-type: none"> • It is normal for the correct amount of coffee to appear overfilled in your portafilter. Untamped coffee has approximately three times the volume of tamped coffee.
Emergency stop?		<ul style="list-style-type: none"> • Press START / PAUSE / CANCEL button to stop operation. • Unplug power cord from power outlet.

GUARANTEE

2 YEAR LIMITED GUARANTEE

Sage Appliances guarantees this product for domestic use in specified territories for 2 years from the date of purchase against defects caused by faulty workmanship and materials. During this guarantee period Sage Appliances will repair, replace, or refund any defective product (at the sole discretion of Sage Appliances).

All legal warranty rights under applicable national legislation will be respected and will not be impaired by our guarantee. For full terms and conditions on the guarantee, as well as instructions on how to make a claim, please visit www.sageappliances.com.

NOTE

NOTE

GBR

BRG Appliances Limited
Unit 3.2, Power Road Studios,
114 Power Road, London, W4 5PY
Freephone (UK Landline): 0808 178 1650
Mobile Calls (National Rate): 0333 0142 970

DEU

AUT

Sage Appliances GmbH
Campus Fichtenhain 48, 47807 Krefeld,
Deutschland
Deutschland: 0800 505 3104
Österreich: 0800 80 2551

FRA

Sage Appliances France SAS
Siège social: 66 avenue des Champs
Élysées – 75008 Paris
879 449 866 RCS Paris
France: 0800 903 235

IRE

Ireland
1800 932 369

NLD

Netherlands
0800 020 1741

ITA

Italy
800 909 773

ESP

Spain
0900 838 534

PTB

Portugal
0800 180 243

POL

Poland
00800 121 8713

BEL

Belgium
0800 54 155

CHE

Switzerland
0800 009 933

LUX

Luxembourg
0800 880 72

DNK

Denmark
80 820 827

SWE

Sweden
0200 123 797

FIN

Finland
0800 412 143

NOR

Norway
80 024 976

Sage®

www.sageappliances.com

Registered in England & Wales No. 8223512
Registered in Germany No. HRB 81309 (AG Düsseldorf)
Registered in France No. 879 449 866 RCS

EN Due to continued product improvement, the products illustrated or photographed in this document may vary slightly from the actual product.

DE Aufgrund unserer kontinuierlichen Produktverbesserungen kann die hier gezeigte Abbildung geringfügig vom tatsächlichen Produkt abweichen.

FR En raison de leur amélioration continue, les produits représentés ou photographiés dans le présent document peuvent différer légèrement du produit réel.

NL Vanwege voortdurende productverbeteringen, kunnen de afgebeelde producten in dit document licht afwijken van het eigenlijke product.

IT A causa del continuo miglioramento dei prodotti, il prodotto descritto o illustrato in questo documento può variare leggermente rispetto al prodotto reale.

ES Perfeccionamos nuestros productos continuamente, por lo que el artículo podría diferir ligeramente de la ilustración o la fotografía en este documento.

PT Devido à melhoria contínua dos produtos, os produtos ilustrados ou fotografados neste documento podem variar ligeiramente do produto real.

PL Ze względu na stale przeprowadzane ulepszenia, produkty przedstawione na ilustracjach lub zdjęciach w tym dokumencie mogą różnić się od używanego produktu.

DA På grund af løbende produktudvikling kan de illustrerede eller fotograferede produkter i dette dokument variere en smule fra det faktiske produkt.

SV På grund av kontinuerlig produktförbättring kan produkterna som visas i illustrationerna och fotografierna i detta dokument skilja sig något från den faktiska produkten.

FI Jatkuvan tuotekehittelyn seurauksena kuvituksen tuotteet eivät välttämättä ole täysin samanlaisia kuin varsinaiset tuote.

NO På grunn av kontinuerlig produktutvikling kan produktene som er vist eller avfotografert i dette dokumentet, variere noe fra det faktiske produktet.

Copyright BRG Appliances 2022

BCG820 / SCG820 UG1 – B22